

PRODUCT SHEET

Description:

Cushion "B" F/SS Clamp "Oval-L", Glass 12mm (3,20mm), Black EPDM

Item number:

22.10.624-5

Units	Box	Carton	HS Code	Barcode
Pcs.	8	1000	4016930090	 5704866507349

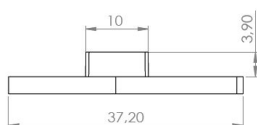
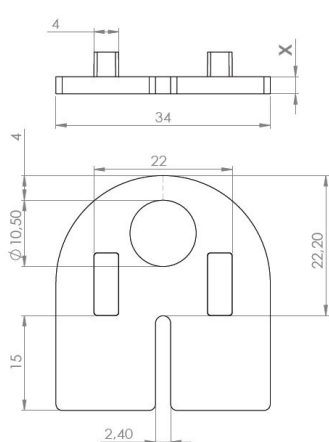

Hardness Shore A = 65 +/- 3

Item:	X (+/- 0,1)	f. glass thickness
22.10.624-6	2,90	12,76
22.10.624-5	3,20	12,00
22.10.624-0	3,75	10,76
22.10.625-0	4,23	10,00
22.10.626-0	4,80	8,76
22.10.627-0	5,25	8,00
22.10.628-0	5,80	6,76
22.10.629-0	6,32	6,00

SISO A/S

Mileparken 11
DK-2740 Skovlunde
Denmark
VAT: DK 24786013

Phone +45 45 830 900

www.siso.dk
siso@siso.dk

Danske Bank
Nytorv Branch
Copenhagen
SWIFT: DABADKKK

Account no.
4180 3112 112936
IBAN Account
DK7230003112112936